

Top Finishes
Melamine (MFC)
Perfect Sense
Writable Laminate.

Telescopic beam.
Epoxy powder painting
Grey
White RAL 9003.

Steel sheet metal Flip top
mechanism with handles.
Polypropylene (PP) cover.

Leg with telescopic rectangular
steel pipe column 80x60 mm
with rectangular steel sheet
metal feet 70x30 mm.
Epoxy powder painting
Grey RAL 9006 polished
White RAL 9003 polished.

4 or 6 resealable module (White, Black or Grey)
painted steel for electricity and/or multimedia
system. Available with single cable management
(optional).

Plastic pen holder.

Height adjustment button with
ISP security system (the table
stops and moves it about 25 mm
away from the obstacles

n. 2 eletric italian
plug Schuko.

Swivel castor with pedal brake \varnothing 75 mm.
Polyamide support with anti-trace
thermoplastic rubber tread.

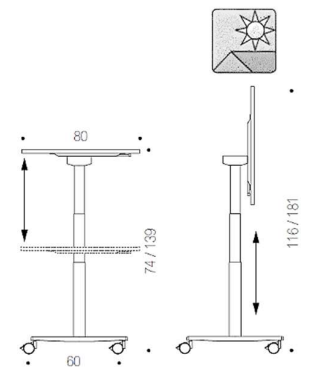

Structure Finishes

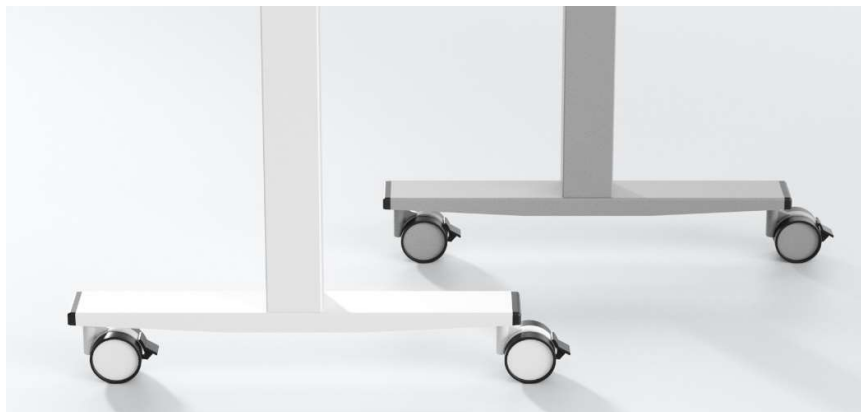

Leg with telescopic rectangular steel pipe column 80x60 mm with rectangular steel sheet metal feet 70x30 mm.
 Epoxy powder painting.
 2 Finishes available:
 Grey RAL 9006 polished
 White RAL 9003 polished.

Shapes and dimension tops



Top Finishes





Single module in ABS for electricity and/or multimedia and system cable management.

KIT06 / A

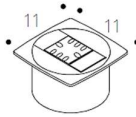

KIT06 / B

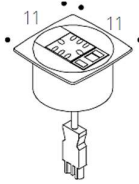

KIT06 / C

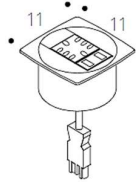

KIT06

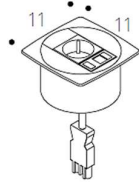

KIT03

Connection cable to joint variable plug power supply system 2 mt (H05VV-F 3G 1.5 mm² / GST18 - GST18)

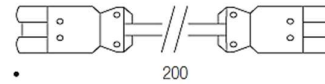

KIT09

Electric cable 2 mt (H05VV-F 3G 1.5 mm² / GST18 – Male Socket)

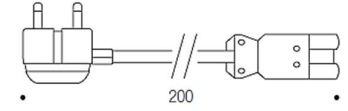

KIT12

Power distributor with 3 poles.

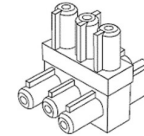

4 or 6 module steel box for electricity and/or multimedia.

KIT07*

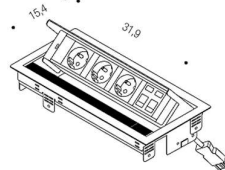

KIT08*

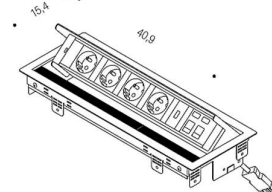

Cable management resealable module (White, Black or Grey) painted steel box.

KIT04*

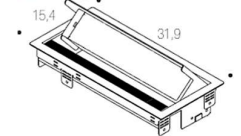

***International Sockets**

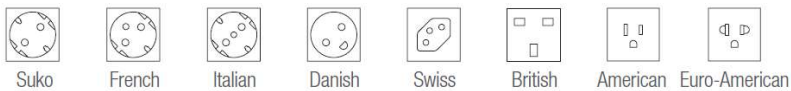

***Multimedia Accessories**

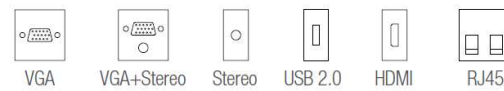

Cleaning

For the metal parts, we recommend to only use a damp cloth with alcohol and to dry all very well after cleaning.
For the lacquered top, use a damp cloth with neutral liquid detergent. Do not use solvents, trichloroethylene, acetone or ammonia.

Guaranteed

Our products are guaranteed for 5 years.
(detailed guarantee document available upon request).



UNI EN 1730:2000

Compliance certificate with BS EN 15372:2008, level 3° severe.



Compliance certificate with EN ISO/IEC 17050-1.